

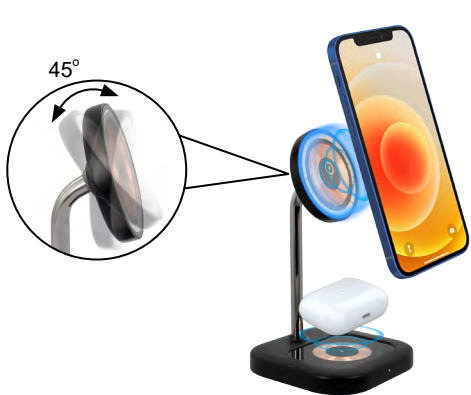

# Sinohero Industrial Ltd

Catalogue 2025 Spring

- **Wireless Charger** P2-12
- **GaN & PD Mode Fast Charger** P13-23
- **Magsafe Case** P24-27
- **Holder for Phone & Tablet** P28-36



## Qi2 2-in-1 Zinc-Alloy Magsafe Wireless Charging Stand

...

Model No. WI00212(Qi2)  
WI00210

### Key Features and Functions

- Baking finish zinc alloy housing with transparent panel on charging area
- Angle of magnetic holder can be adjusted
- Strong N52 magnets inside
- Compatible with iPhone 16/15/14/13/12 series, and certified MagSafe Cases
- USB-C input: PD20W
- Output: Magnetic Wireless: 15W Max, AirPods Wireless: 5W
- Qi/CE/FCC/RoHS compliant

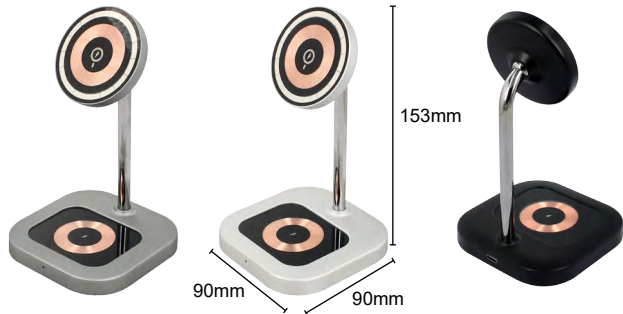



## Qi Magsafe Streamline 15W Wireless Fast Car Charger

...

Model No. WP00376

### Key Features and Functions

- Strong N52H magnets inside, holding on IP12 or later firmly and easily
- Streamline design with transparent panel & metallic paint housing
- Clamp style air-vent clip with support plate, easy to install and more stable
- Can be rotated freely, also can change the car mount by yourself easily
- USB-C input: 5V/3A, 9V/2.22A, 12V1.5A(support QC3.0 or PD 20W)
- Output: 15W/10W/7.5W/5W
- Qi/CE/FCC/RoHS compliant



# Qi2 Certified Magsafe Windshield&Dashboard 15W Wireless Car Charger

## Key Features and Functions

- Strong N52H magnets inside, holding on IP12 or later firmly even if hang it
- Embossed charging area, won't interfere the camera of iPhone
- Metallic paint frame surrounded light, enhanced heat emission hole
- USB-C input: 5V/3A,9V/2.22A,12V1.5A(support QC3.0 or PD 20W)
- Output: 15W/10W/7.5W/5W
- Suction cup with sticky gel, can be mounted onto windshield or any other flat surfaces
- Telescopic tube length range from 118-170mm
- Gimbal adjustor with tighten knob, full 360 degree rotation
- Qi/CE/FCC/RoHS compliant

Model No. WP00378





## Qi Magsafe Dual-Circle 15W Wireless Fast Car Charger

...

### Key Features and Functions

- Strong N52H magnets inside, holding on IP12 or later firmly and easily
- Unique design with acrylic transparent panel
- Clamp style air-vent clip with support plate, easy to install and more stable
- Can be rotated freely, also can change the car mount by yourself easily
- USB-C input: 5V/3A,9V/2.22A,12V1.5A(support QC3.0 or PD 20W)
- Output: 15W/10W/7.5W/5W
- Qi/CE/FCC/RoHS compliant

Model No. WP00377





# Transparent Panel + Circle Light Magsafe 15W Wireless Fast Car Charger

## Key Features and Functions

- Strong N52H magnets inside, holding the IP16/15/14/13/12 firmly
- Acrylic transparent panel, transparent frame with circle light inside
- Embossed charging area, won't interfere the camera of iPhone
- Clamp style air-vent clip with support plate, easy to install and more stable
- Can be rotated freely, also can change the car mount by yourself easily
- USB-C input: 5V/3A,9V/2.22A,12V1.5A(support QC3.0 or PD 20W)
- Output: 15W/10W/7.5W/5W
- Qi/CE/FCC/RoHS compliant

Model No. WP00373



WP00372

(without circle light)

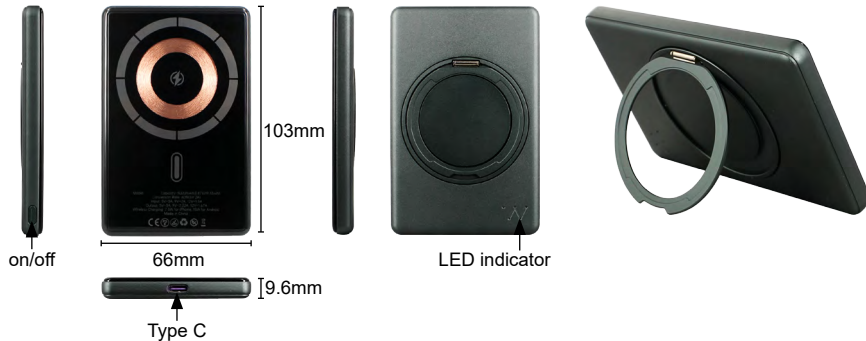

# Ultra Slim 5000mAh Magsafe Wireless Charging Power Bank with 360° Rotating Kickstand

## Key Features and Functions

- Full Aluminium Housing with acrylic transparent panel
- Zinc hinge kickstand can be 360°rotated
- Size only 103x66x9.6mm, holding on IP12 or later firmly and easily
- Built-in UL approved A grade 5000mAh Li-poly battery cell
- USB-C input: DC5V/3A, 9V/2.22A, 12V/1.67A (QC3.0 or PD20W)
- Two outputs: Wireless:15W/10W/7.5W/5W, USB-C: PD 20W. When charge 2 devices at the same time, share 5V/3A
- On/off switch, 5 LEDs indicate working status and battery volume
- Qi/CE/FCC/RoHS compliant

Model No. WP05306



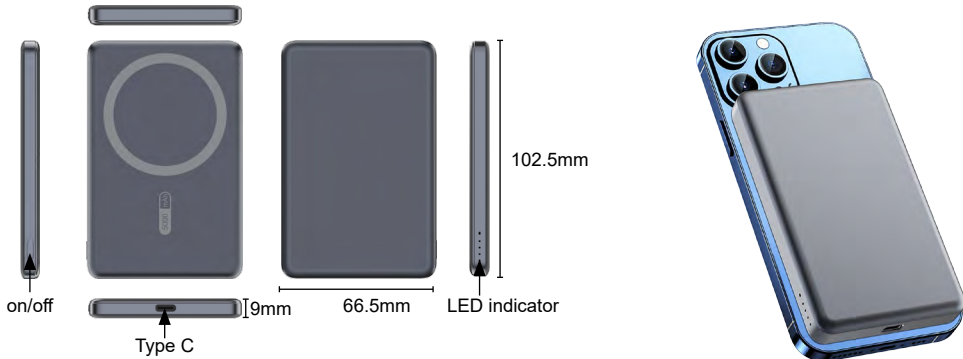

# Full Aluminium Housing Slim 5000mAh Magsafe Wireless Charging Power Bank

...

Model No. WP05227

## Key Features and Functions

- Built-in UL approved A grade 5000mAh Li-poly battery cell
- Mini size only 102.5\*66.5\*9mm, holding on IP12 or later firmly and easily
- USB-C input: DC5V/3A, 9V/2.22A, 12V/1.67A (QC3.0 or PD20W)
- Two outputs: Wireless: 15W/10W/7.5W/5W, USB-C: PD 20W.
- When charge 2 devices at the same time, share 5V/3A
- On/off switch, 5 LEDs indicate working status and battery volume
- Qi/CE/FCC/RoHS compliant







# Super Slim 5000mAh Rubberized Magsafe Wireless Charging Power Bank

Model No. WP05222

## Key Features and Functions

- Built-in UL approved A grade 5000mAh Li-poly battery cell
- Size only 10x69x105mm, holding on IP12 or later firmly and easily
- USB-C input: DC5V/3A, 9V/2.22A, 12V/1.67A (QC3.0 or PD20W)
- Two outputs: Wireless: 15W/10W/7.5W/5W, USB-C: PD 20W. When charge 2 devices at the same time, share 5V/3A
- On/off switch, 5 LEDs indicate working status and battery volume
- Qi/CE/FCC/RoHS compliant



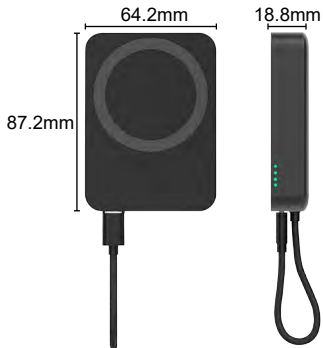

# Aluminium Housing Magsafe Wireless Charging 10000mAh Power Bank with Fixed USB-C Cable

Model No. WP10311

## Key Features and Functions

- Built-in UL approved A grade 10000mAh Li-poly battery cell
- Compact size only 88x64x18.8mm, holding on IP16/15/14/13/12 firmly and easily
- USB-C cable input: DC5V/3A, 9V/2A(QC3.0 or PD20W)
- Three outputs: Wireless:15W/10W/7.5W/5W, USB-C cable:PD20W, USB-C port: PD18W.  
When charge 2 or 3 devices at the same time, share 5V/3A
- On/off switch, 4 LEDs indicate battery volume
- Qi/CE/FCC/RoHS compliant

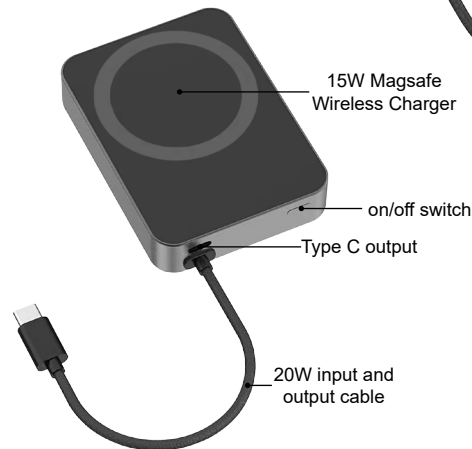



## Full Aluminium Housing & Zinc Hinge Kickstand Magsafe Wireless Charger

Model No. WP00174  
WP00175(Qi2)

### Key Features and Functions

- Strong N52H magnets inside, holding on IP12 or later firmly even if hang it
- Full Aluminium Housing with soft silicon pad, size D59x8.3mm
- Compatible with MagSafe phone cases
- USB-C input: DC5V/3A, 9V/2.22A, 12V/1.67A (QC3.0 or PD20W)
- Output: 15W/10W/7.5W/5W
- Qi/CE/FCC/RoHS compliant
- Qi2 version available



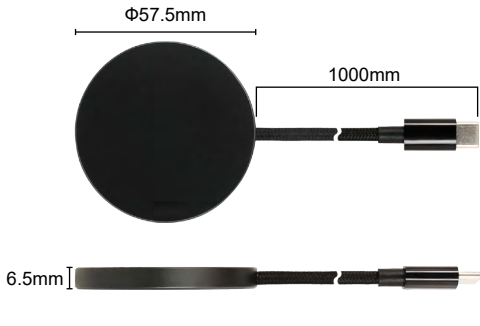

# Qi2 Aluminium Housing Magsafe 15W Wireless Charger with 1m Braided Cable

## Key Features and Functions

- Aluminium housing with soft silicon pad, size D57.5x6.5mm, cable length 1m
- Strong N52H magnets inside, holding on IP12 or later firmly even if hang it
- Input interface: USB-C male
- Input: DC5V/3A, 9V/2.22A, 12V/1.67A (QC3.0 or PD20W)
- Output: 15W/10W/7.5W/5W
- Qi/CE/FCC/RoHS compliant

Model No. WP00176





**10000mAh**  
Power Bank

iPhone 15  
**1.83 charges**

iPhone 15 Pro  
**2 charges**

11" iPad Pro (2022)  
**0.81 charges**

Samsung S24 Ultra  
**1.29 charges**



Foldable Wall Charger



# ETL Certified PD65W Digital Display 10000mAh Built-in Type-C Cable Wall Charger Power Bank

...

**Model No. UC31636**

## Key Features and Functions

- Smart digital display indicates working status and battery volume, brightness adjustable
- UL approved A grade 10000mAh Li-ion battery cell inside
- Two input modes: AC100-240V,50/60Hz,1.7A or Type C port PD30W
- Output(AC mode): C-port: PD65W, C-cable:PD20W, C-port+C-cable: PD45+PD20W
- Output(power bank mode): C-port: PD30W, C-cable:PD30W, C-port+C-cable: share 5V/4A
- Portable size 120x52x36mm, weight 292g, foldable US standard plug
- ETL/CE/FCC/RoHS compliant



Charge a 14" MacBook Pro (M2) to 50% in

**32 Min**

Charge an HP Chromebook 14 to 50% in

**37 Min**



Boost HP Spectre x360 to **42%**

Boost HP Chromebook 14 to **62%**

Boost 14" MacBook Pro (M2) to **39%**

## Smart Display

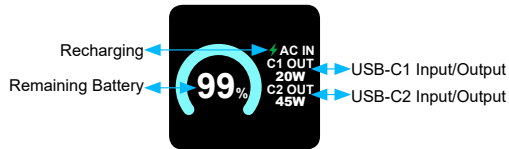

Recharging

Remaining Battery

AC IN

C1 OUT 20W

C2 OUT 45W

USB-C1 Input/Output

USB-C2 Input/Output

Screen Off Time  
Press twice to switch.

**30s**

**1 Min**

**5 Min**

**30 Min**

Long Press to Exit Settings

Screen Brightness  
Press twice to switch.

**High**

**LoW**

Long Press to Exit Settings

# GaN Slim&Mini ETL/CE Approved PD100W Universal AC Adaptor for Laptop & Drone with Fixed USB-C Cable

Model No. PC00310

## Key Features and Functions

- Widely used for all Laptops with USB-C charging interface and many kinds of Drones
- Input: AC110-240V, 50/60Hz, detachable power cord, length 1.2M, US/EU/UK plug available
- USB C connector, output 5V/3A,9V/3A,12V/3A,15V/3A,20V/5A
- Extra USB-A port, output QC3.0(18W) to charge other suitable devices, such as controller of drone
- High shine plastic housing, dimension 114x55x22mm
- Strip blue LED indicator
- ETL/CE/FCC/RoHS compliant

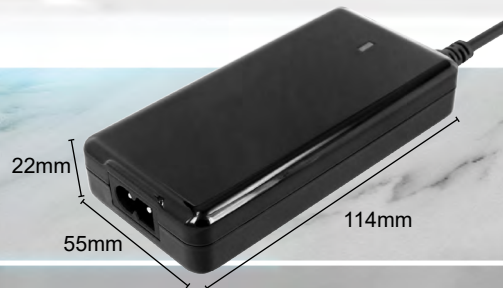

**PA03486(US)**

**PA03489(EU)**

**PA03490(UK)**

- PD3.1 GaN ETL&CE approved **140W** PD mode 4-port wall charger
- Output: when one port work alone, C1: PD140W, C2: PD140W, C3: PD30W, USB-A: QC4.0(30W)  
When work simultaneously, total output: 140W  
C1+C2: PD70W+PD70W, C3+A: 5V/3.6A  
C1/C2+C3: PD100W+PD30W, C1+C2+A: PD65W+PD45W+QC3.0(18W)  
C1/C2+A: PD100W+QC4.0(30W), C1/C2+(C3+A): PD100W+5V/3.6A(C3&A share)  
C1+C2+(C3+A): PD65W+PD45W+5V/3.6A(C3&A share)
- US/EU/UK standard AC plug
- Size: 67\*63\*31mm, net weight 215g



### **PA03492**

- GaN ETL&CE approved **65W** PD mode 4-ports desktop charging station
- Output: when one port work alone, Type C: PD65W, USB-A:QC3.0(18W)
- When work simultaneously
  - C1+C2: PD45W+PD20W,
  - A1+A2:12W+12W
  - C1/C2+A1/A2: PD45W+QC3.0(18W)
  - C1+C2+A1/A2: PD30W+PD20W+12W
  - C1/C2+A1+A2: PD30W+12W+12W
  - C1+C2+A1+A2: PD30W+PD20W+12W(A1&A2 share)
- Size: 99x91.3x23.7mm
- Length 1.5m AC power cable, US/EU/UK/AUS plug available
- ETL/cETL/CE/FCC compliant

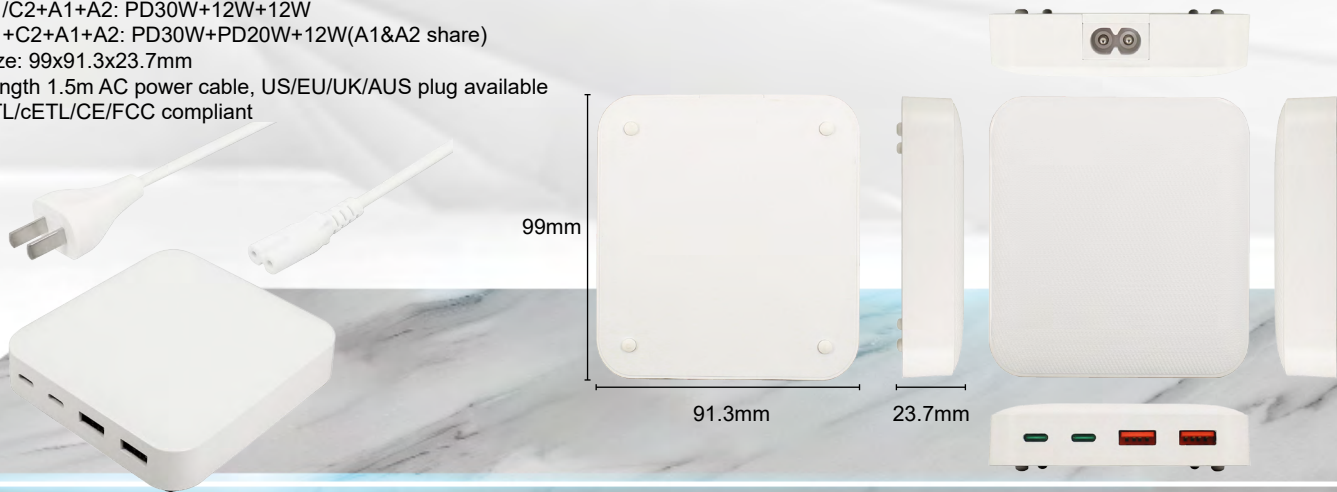



**PA03360(US)**

**PA03362(EU)**

**PA03363(UK)**

- GaN ETL&CE approved **65W** PD mode 3-ports mini travel charger
- Output: when one port work alone, C1:PD65W, C2:PD20W, USB-A: QC3.0(18W)  
When work simultaneously  
C1+C2 : PD45W+PD20W  
C1+A: PD45W +QC3.0  
C2+A: 5V/3A(shared)  
C1+C2+A: PD45W+5V/3A(C2&A shared)
- Size: 62x45x28mm
- US/EU/UK standard AC plug
- ETL/cETL/CE/FCC/Rohs compliant



**PA03277(US)**

**PA03278(EU)**

**PA03279(UK)**

- GaN ETL&CE Approved **48W** PD Mode Dual Output Wall Charger
- Output: when one port work alone, USB-C: PD45W, USB-A: QC3.0(18W)  
when work simultaneously, output: PD30W+QC3.0(18W)
- Total power 48W
- US/EU/UK standard AC plug
- Size: 62\*45\*28mm
- ETL/cETL/CE/FCC compliant

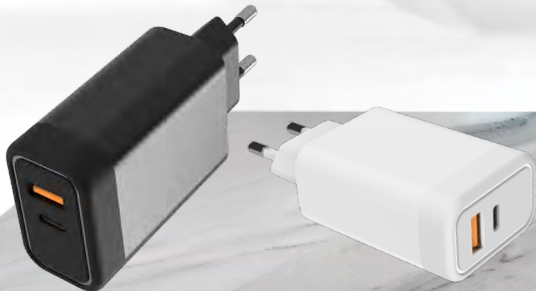
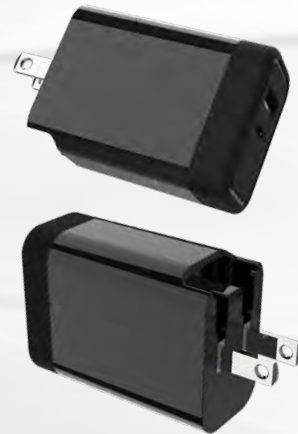

### **PA03202**

- GaN Mini ETL&CE Approved **45W** PD Mode Dual USB-C Travel Charger
- Output: C1/C2: 45W, C1+C2: 25W +20W
- Foldable USA standard Plug
- Size: 54x35x30mm
- ETL/cETL/CE/FCC compliant

### **PA03930**

- ETL approved **30W** PD mode travel charger
- Type C output: 5V/3A, 9V/3A, 12V/2.5A, 15V/2A, 20V/1.5A, PPS: 3.3V-11V/2.7A, 3.3V-16V/1.7A
- Size: 45x42x28mm
- Foldable USA standard AC plug
- ETL/cETL/CE/FCC compliant



### **PA03839(US)**

- GaN PD**75W** Desktop Charger with USA Standard 3-Phase AC Socket
- Output interface: 3xUSB-C, 2xUSB-A, 3xSocket
- Input: AC100-250V/10A, rated power 1250W
- Output:
  - USB-C1/C2/C3: 5V/3A,9V/3A,12V/3A,15V/3A,20V/3.35A
  - USB-A1/A2: 5V/3A,9V/3A,12V/3A,20V/3A
  - USB-C1+C2 / C1+C3 / C2+C3: 45W+30W
  - USB-A1+A2: 45W+30W
  - USB-C1+C2+C3: 35W+20W+20W
  - USB-C1+(C2+C3)+(A1+A2): 45W+15W+15W
  - USB-C1+(C2+A1)+(C3+A2): 45W+15W+15W
- Total output of USB ports: 75W max
- Compact and sleek design, size 98.2x48x44.3mm
- Fixed cable length 1.8m, US standard 3-Phase AC plug
- UL/cUL/CE/FCC/ROHS compliant

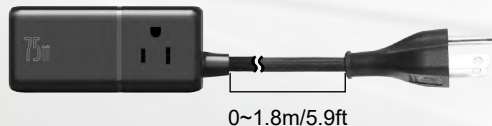

### **PA03840(EU)**

- Europe standard 1x Socket and AC plug
- Rated power 2500W



### **PA03841(UK)**

- UK standard 1x Socket and AC plug
- Rated power 2500W



# GaN Super Mini PD65W Full Metal Car Charger

...

Model No. PA02980

## Key Features and Functions

- GaN Super Mini PD65W USB C+A Dual Output Full Metal Housing Car Charger
- Zinc-alloy housing size only D20.5x42mm, can be inserted in cigar socket completely
- Special designed zinc-alloy tab, take it out from socket easily
- Output: when one port work alone, USB-C PD65W (if input is DC12V, output is PD30W), USB-A 30W(QC3.0), when work simultaneously, two ports share 5V/3A.Total power 65W max
- CE/FCC/ROHS compliant



### PA02981

- Dual USB-C mode
- Output: C1/C2: PD40W
- C1+C2: PD20W+PD20W

# GaN Slim&Mini PD100W Universal Car Charger for Laptop & Drone with Fixed USB-C Cable

...

## Key Features and Functions

- Widely used for all Laptops with USB-C charging interface and many kinds of Drones
- Input: DC12-24V, detachable car cigar power cord, length 0.8M
- USB-C output: 5V/3A,9V/3A,12V/3A,15V/3A,20V/5A
- Extra USB-A port, output QC3.0(18W) to charge other suitable devices, such as controller of drone
- High shine plastic housing. dimension 114x55x22mm
- Strip blue LED indicator
- CE/FCC/RoHS compliant

Model No. PC00296



### **PA02210**

- **PD100W** Dual Type C Full Metal Housing Car Charger
- Input: DC12-24V
- Output: C1/C2:100W  
C1+C2:65W+35W
- Full aluminium housing, dimension D33x70.2mm
- Total power 100W max
- CE/FCC/ROHS compliant



### **PA02313**

- **130W** Three Ports Carbon Fiber Surface PD Mode Car Charger
- High shine plastic housing with carbon fiber surface, size: D43x83.7mm
- Output: USB-C1 PD100W, USB-C2 PD30W, USB-A QC3.0 30W, when 2/3 ports work at the same time,  
C1+A1: PD100W+30W  
C1+C2: PD100W+PD30W  
A1+C2: share 5V/4.8A(24W)  
C1+A1+C2: PD100W+ 5V/4.8A(A1&C2 share)
- Total power 130W max
- CE/FCC/ROHS compliant





# Two-Layers TPU+PC Magsafe Case

...

Model No. PT-124

- Two-Layers Protection TPU+PC Magsafe Shock Absorption Case
- Matting hand feel surface, anti-scratch and anti-finger mark
- Strong N52/2400 gauss magnets with added metal sheet inside, suction force up to 1.2kg
- Fast & stable wireless charging, no signal effect, 360 degree rotation charging
- Four corners with shock absorption bumper design, drop test up to 1.2m
- Front edge higher 1.2mm than screen, back camera edge 1.6mm raised, anti-scratch protection
- Rear panel total thickness 3.3mm, rim thickness 1.8mm, 8 colors available
- Available models: iPhone 15/16 series, Samsung GS24/24FE/GS25 series etc

360°  
Protection



Added Metal Sheet Inside,  
Suction Force up to 1.2kg







# High Clear Thicker TPU+PC Magsafe Case

Model No. PT-122

- High Clear Thicker TPU+PC Magsafe Shock Absorption Case
- Matt soft rim surface, high clear rear panel, anti-scratch, anti-yellow and anti-finger mark
- Strong N52/2400 gauss magnets, suction force up to 1.2kg
- Fast & stable wireless charging, no signal effect, 360 degree rotation charging
- Four corners with shock absorption bumper design, drop test up to 1.2m
- Front edge higher 1.2mm than screen, back camera edge 1.6mm raised, anti-scratch protection
- Rear panel thickness 2.0mm, rim thickness 2.2mm, 7 colors available
- Available models: iPhone15/16 series, Samsung GS24/24FE/GS25/A16 series etc



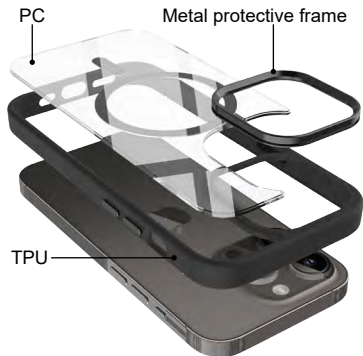

# Metal Rim & Button Thicker TPU+PC Magsafe Case

Model No. PT-118

- Metal Rim & Button Thicker TPU+PC Magsafe Shock Absorption Case
- Rim of camera and separate buttons all use metal material, glossy and durable
- Matt rim surface, high clear rear panel, anti-stain and anti-finger mark
- Strong N52/2400 gauss magnets, suction force up to 1.2kg
- Fast & stable wireless charging, no signal effect, 360 degree rotation charging
- Four corners with shock absorption bumper design, drop test up to 1.2m
- Front edge higher 1.2mm than screen, back camera edge 1.6mm raised, anti-scratch protection
- Rear panel thickness 2.0mm, rim thickness 2.2mm, 7 colors available
- Available models: iPhone 15/16 series, Samsung GS24 series etc



Independent metal key



**Long-lasting Crystal Clear**  
Non-yellowing, keep it safe and original



Anti-Fingerprints



Anti-stain



Anti-scratch



# Thicker TPU+PC Magsafe Crystal Case

Model No. PT-110

- Thicker TPU+PC Magsafe Crystal Transparent Shock Absorption Case
- Thickness of TPU and PC all are 2mm
- Strong N52/2400 gauss magnets, suction force up to 1.2kg
- Fast & stable wireless charging, no signal effect, 360 degree rotation charging
- Four corners with shock absorption bumper design, drop test up to 1.2m
- Front edge higher 1.2mm than screen, back camera edge higher 0.5mm, anti-scratch protection
- Available models: iPhone15/16 series/SE4 , Samsung GS23/24/25 series/A16/Z5/Z6, Google pixel 9 series



## Upgraded Camera & Screen Protection

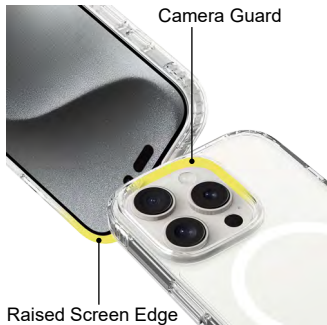

**NO.1 Stronger Magnetic Lock**  
Super Strong Magnet Holds Seamlessly

**ANTI-YELLOW & ANTI-DROP**  
Double Reinforced Protection Material

Thickness of hard PC backplane -2.0mm

Flexible TPU with Air Cushion

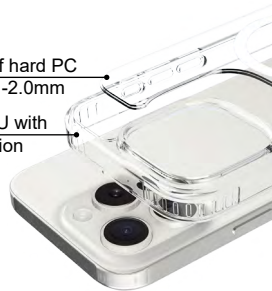



# Hollow Circle Windshield&Dashboard 2 in 1 Telescopic Magsafe Car Holder

Model No. CX02020

## Key Features and Functions

- Built-in full circle N52 strong magnets
- Firmly attach directly to the IP12 or later and all mobile phones with Magsafe case
- Special and outstanding logo position
- 360 degree easy rotation





## Hollow Circle Streamline Magsafe Air-vent Car Holder

...

Model No. CX02021

### Key Features and Functions

- Built-in full circle N52 strong magnets
- Firmly attach directly to the IP12 or later and all mobile phones with Magsafe case
- Special and outstanding logo position
- 360 degree easy rotation



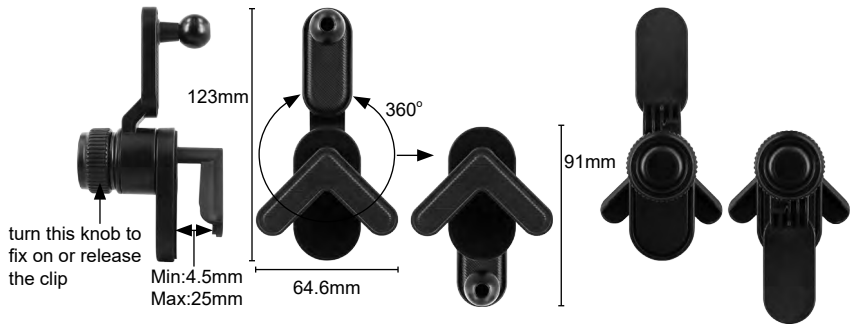

# Car Screen Corner Clamp Magsafe 360 Degree Rotation Holder

Model No. CX06003

## Key Features and Functions

- Latest corner clamp design, suitable thickness of screen up to 2.5cm
- Through control knob to fix the clamp easily, ball shaft can be 360 degree rotated
- Built-in N52 strong magnets, firmly attach directly to IP12 or later and all mobile phones with Magsafe case
- High shine central Logo position





Φ60.3mm



28.5mm



# Benz Air-vent Zinc-Alloy Magsafe Car Holder

Model No. CX06004

## Key Features and Functions

- Latest designed elastic air-vent clip, fit for Benz air-vent perfectly, also can be used for other special air-vent
- Zinc-alloy high class magsafe holder, can be made into a variety of colors
- Built-in N52 strong magnets, firmly attach directly to IP12 or later and all mobile phones with Magsafe case
- 360 degree easy rotation

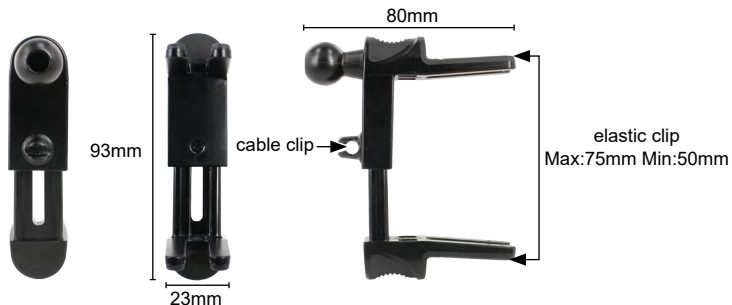



## Anywhere Dual Sticker Flexible Magsafe Car Holder

...

Model No. CX02019

### Key Features and Functions

- Ultra-flexible multi-axis adjustable design, allowing for various installation positions and angles
- Built-in N52 strong magnets, firmly attach directly to IP12 or later and all mobile phones with Magsafe case
- Matt panel + gloss loop dual color magsafe holder
- Red 3M durable sticker, no residual when tear off
- 360 degree easy rotation







# Carbon Fiber Frame Windshield & Dashboard 2 in 1 Telescopic Magsafe Car Holder

...

Model No. CX02018

## Key Features and Functions

- Carbon fiber frame plastic housing with cable clip on back
- Built-in N52 strong magnets, firmly attach directly to IP12 or later and all mobile phones with Magsafe case
- Suction cup with sticky gel, can be mounted onto windshield or any other flat surfaces
- Telescopic tube length range from 118-170mm
- Gimbal adjustor with tighten knob, full 360 degree rotation





## Windshield & Dashboard 2 in 1 Telescopic Zinc-Alloy Magsafe Car Holder

...

Model No. CX03012

### Key Features and Functions

- Zinc-alloy high class magsafe holder, can be made into a variety of colors
- Built-in N52 strong magnets, firmly attach directly to IP12 or later and all mobile phones with Magsafe case
- Suction cup with sticky gel, can be mounted onto windshield or any other flat surfaces
- Telescopic tube length range from 112-168mm
- Gimbal adjustor with tighten knob, full 360 degree rotation





## Highlight Logo Position Magsafe Air-vent Car Holder

...

Model No. CX02016

### Key Features and Functions

- Built-in full circle N52 strong magnets
- Firmly attach directly to the IP12 or later and all mobile phones with Magsafe case
- Screwing type fastness air-vent clip
- 360 degree easy rotation





sticky silicon pad



lock knob

83mm

Φ73mm



# Matt Acrylic Panel Dashboard Magsafe Car Holder

...

Model No. CX02017

## Key Features and Functions

- Built-in full circle N52 strong magnets
- Firmly attach directly to the IP12 or later and all mobile phones with Magsafe case
- Stick-Grip suction cup base, can be mounted onto any flat surfaces
- 360 degree easy rotation



Φ58.5mm

24.7mm

**Sinohero Industrial Ltd** is an experienced enterprise devoted to the R&D and manufacture of accessories for Smart phones and Tablets, including Wireless charger, USB charger, Holder, USB cable and so on. Our products enjoy a good reputation in North America and Europe market.

### **Strong R&D ability**

By re-investing 30% of our annual revenue in R&D, we develop new items continuously according to the demand of the market. We conduct our R&D in various aspects, including circuit design, industrial design, configuration, material and modeling. We specialize in Power supply and Car accessories.

### **Quality control**

We execute strict inspections from raw materials to final products to make sure all of your requirements are met.

### **Certifications for Easy Market Entry**

Our products carry CE, UL/ETL, FCC, E-Mark and MFI approvals and comply with the RoHS, CP65 and Reach Directives.

### **Welcome OEM/ODM Orders**

We welcome OEM/ODM orders. To benefit from our R&D ability, contact us now.

**Office:** 2801#,WenAn Center,WenJin Square,1010 Wenjin Road(North), Luohu,Shenzhen, China

**SZ Factory:** Building A, 8 Chenwu Road, Dakang, Henggang, Longgang, Shenzhen

**Huizhou Factory:** 10F, Building 8, Meilonghu Intelligent Manufacturing Industrial New Town, Huiyang, Huizhou, Guangdong

Tel:+86 755 83418318,83418898

Email: sales@sinohero.cn

Website: [www.sinohero.cn](http://www.sinohero.cn)